

1000W LED Stadium Light

Professional LED lamp replacing 3000W Metal halide lamp
High power Philips 5050 LED light source



Product Name : 1000WLED Stadium Light

Part No: TY-LM19-1000W

Approval No : 2018121901



Tonya guarantee that all products being sold are QC passed, and reached the standard for shipment with 5 years warranty



1. Dimensional Drawing(mm)

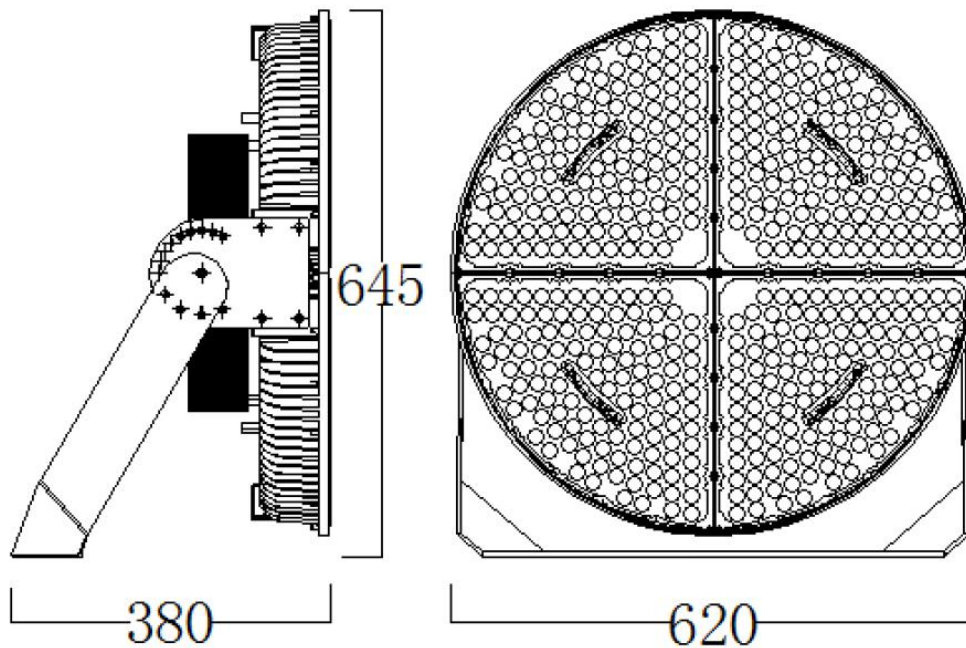

Notes:

1. All dimension units are millimeters.
2. All dimension tolerance is ± 1 mm unless otherwise noted.

2. Features

- Lumileds SMD 5050 LED, Single LED Package Design
- System Design Integrating Power Supply, LED Light Engine, and Heat Sink
- Over Current, Over Voltage, Over Heat, Thunder Protection
- Choice of Correlated Color Temperatures
- (Specification Re-Defined Accordingly)
- Long lifespan for LED 50,000 hrs
- 100%Recycle,No Pollution,and UV,IR

3. Specification

● Optical

Input Voltage	90~295V AC, 50/60Hz
Power Consumption	≅ 1000W (of Total System)
Power Factor	≅ 0.95
Surge	Pass
Fixed Current	Deviation < 1%
Power Efficiency	>90%
EMI Grade	EMI Class B
Protection	Over Current/Over Voltage/Over Heat/Thunder Protection
Luminance Efficacy	>160lm/W

● Electrical

Par NO Parameter	TY-LM19WL-1000W	TY-LM19DW-1000W	TY-LM19WW-1000W
Input voltage	AC85V~277V 50/60HZ		
Light Fixture Luminance (lm)	161000	160000	159000
LED type of smd	480pcs Lumileds 5050		
Beam Angle	10/25/60°		
Color Temperature	5500-6500k	4000-4500k	2700-3500k
Driver	Meanwell driver		
IP Rating	IP66		

● Mechanical and System

IP Level	IP66
Housing	Al alloy
Dimension	850 X670 X 260 mm
NET Weight	25Kg
Heat Solution	Convection

4. Photometry

● Beam Angle and Polar Diagram of Luminance

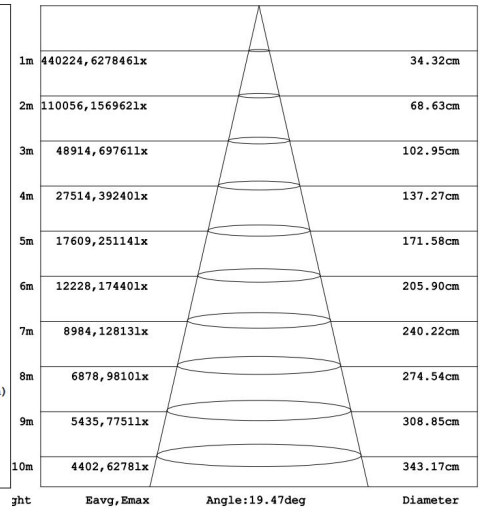
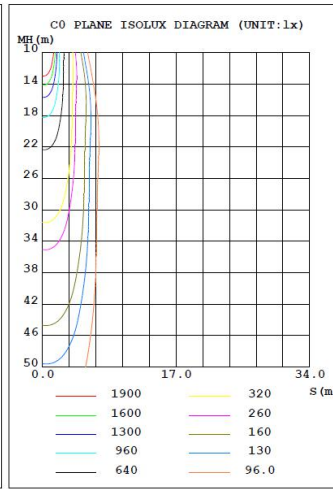
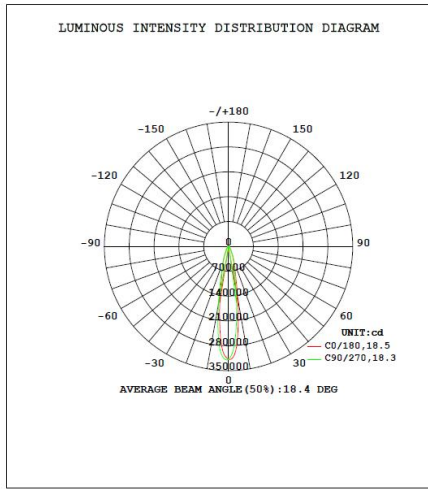

10Degree

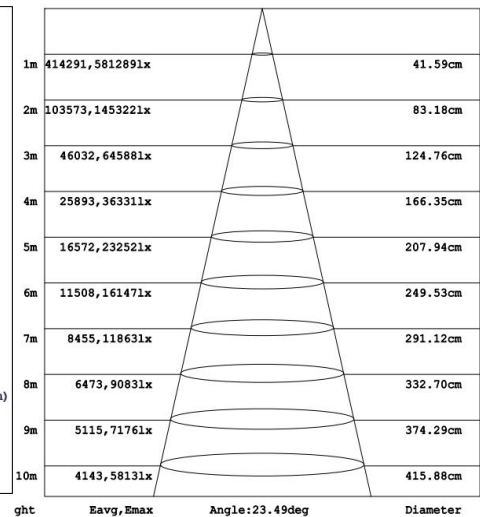
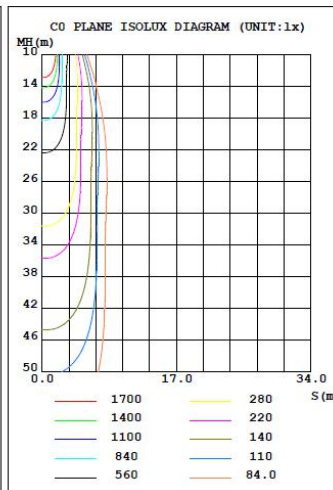
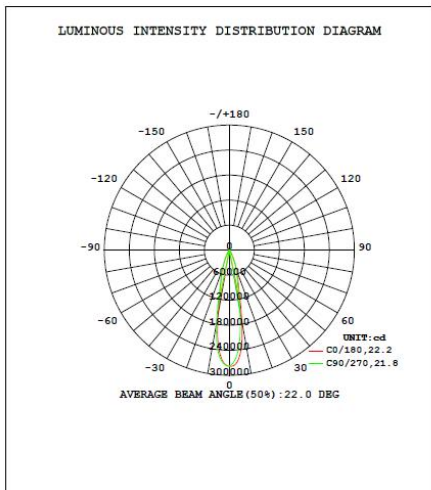

25Degree

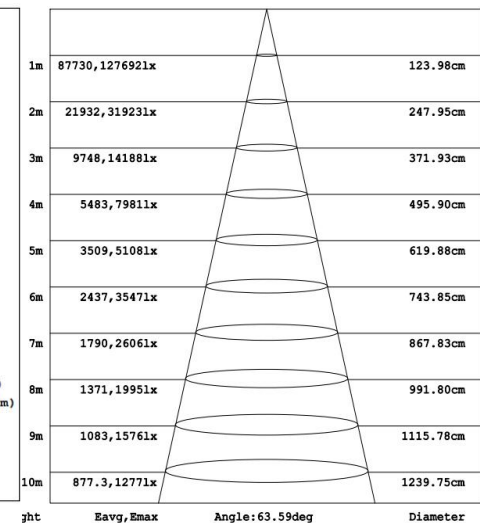
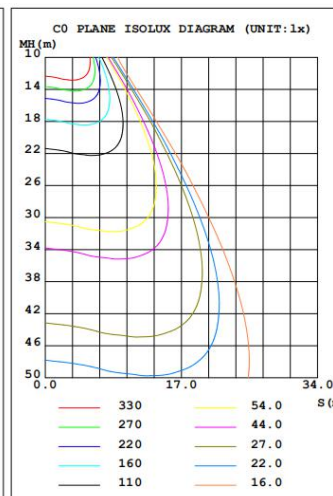
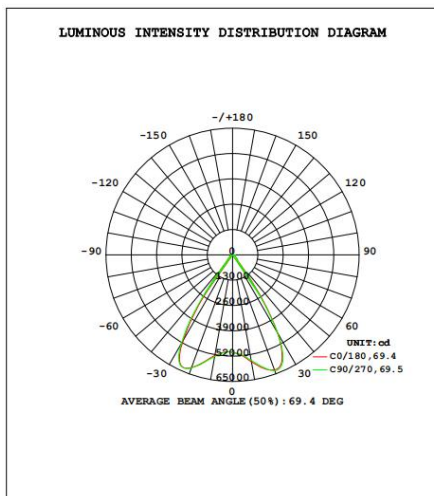

60Degree

5. Application



6. Operation and Storage Condition

- Operation Ambient Temperature -40 to +60°C, Relative Humidity 20~90%
- Input Voltage AC85-295V, 50/60Hz
- Storage Ambient Temperature -40 to +85°C, Relative Humidity 5~95%
- Mounting Height : Suitable for 8~40m height

7. Certificate

- LED Lighting Certificated with CE
- Power System Certificated with UL
- The Whole Floodlight Certificated with CE

8. Package

- 1 Set=620X495X230MM NW:14Kg
- Carton Size : 620X495X230mm
- 1 Carton=1 Set Net Weight:14Kg

9. Assembly and Installation

● Assembly-Electricity

- Blue : Line
- Brown : Neutral
- Yellow-Green : Ground

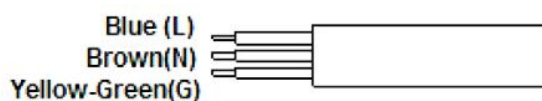

● Installation

- The entire series of LED flood light are designed with wide range voltage, the voltage range is ac85-265volts, the frequency is 50/60Hz.
- Installation tool: A adjustable wrench group.
- Installation Steps :
 1. Tighten Axle Screw, and Locate Screw
 2. Connecting the power line of LED Flood Light to the power supplier ,finish the installation procedure.

10. The installation notices

3. No necessary using other devices for LED Flood light installation such as stabilizer, regulator and so on.

4. Opening the light and lifting the buckle is unallowable.
Soaking in the water is unallowable.

11. Warning

- Do Not Use Other Devices for LED Floodlight Installation Such as Stabilizer, Regulator ...etc
- Do Not Open the Light Engine
- Do Not Soak the Floodlight into Water
- Do Not Light up the System Without Grounding
- Do Not Use Dimmer

12. Warranty

- 5 Years Warranty Starts from Taking Delivery of Goods a Day. The Warranty Content Includes the Damage of All Components, Such as LED Light Source and Power Supply...etc.
- The Calculation of Warranty Period with Turn on the Light for a Day 8-10 Hours is Limited. As Everyday Longer Than 10 Hours, Then Gradually Decrease According to Comparison Warranty Time Limit.
- The Floodlight Must Operate at the Common Normal Environment. As in Order to be Faced by the Sea Road in 3 Kilometers or to Use in the Bad Environment Such as Tunnel, Warranty Period is Within 1 Year.
- This company must be authorized to have maintenance cost under the following situations.
- The Floodlight hasn't Operated According to the Stipulation Under the Common Normal Environment and Thus causes the Breakdown Destruction.
- Damaging of the Product Are Irresistible (Disasters, Person Disaster, Earthquake, Thunder Stroke, Typhoon...etc), the Artificial Destruction (Fallen Wound, to Strike, to Hit Hard and so on), the Artificial Mistake (Losing, Wars, Not to Take Care of Properly and so on) or Other Unusual Factor Result.
- Customers or Other Guys Add Attach, The Expansion the Revision to repair by themselves.